

Weighing & Inspection

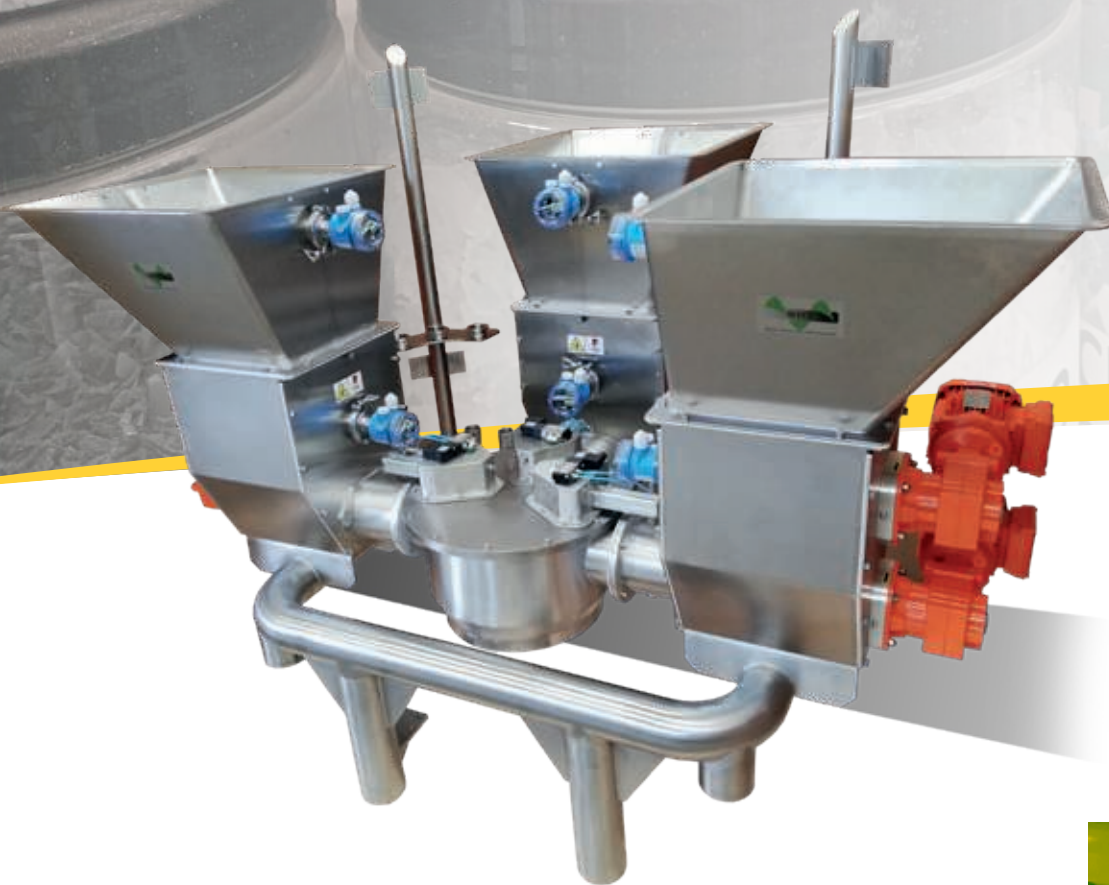

Gravimetrische & Volumetrische Doseersystemen



Weighing & Inspection biedt u een breed gamma aan

van loss-in-weight doseerapparatuur, geschikt voor:

- poeders
- pellets
- vezels
- pasta
- vloeistoffen

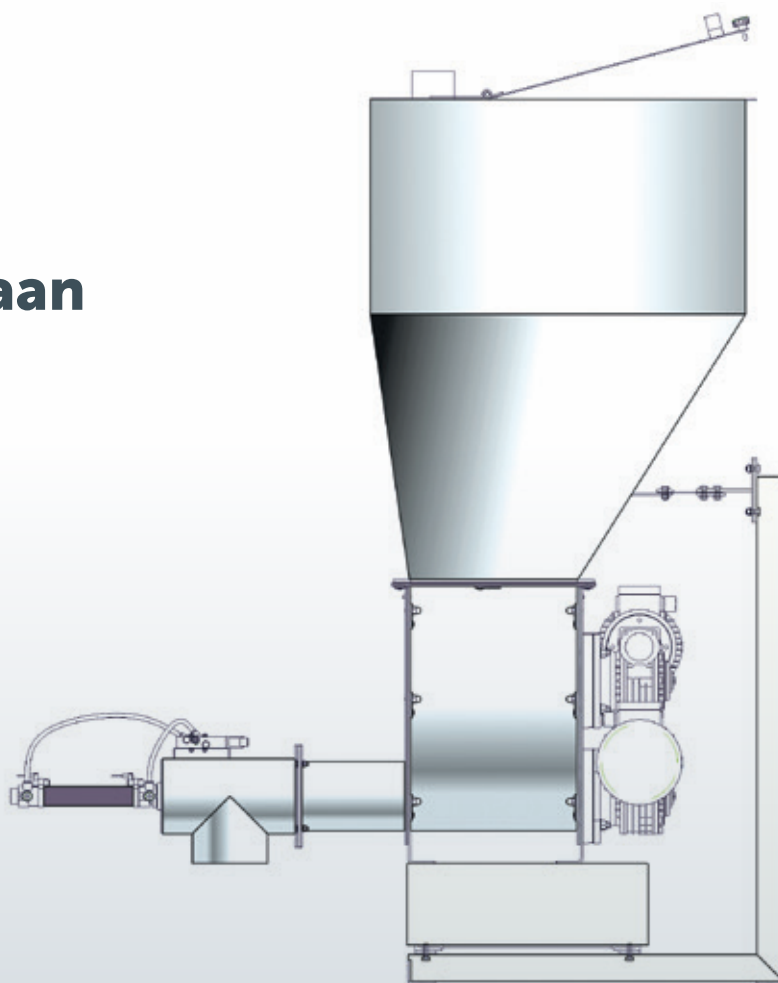

Onze oplossing is steevast op uw maat



Principe loss-in-weight

Het principe van loss-in-weight is het continu meten van de afname in gewicht per tijdseenheid. Dit wordt vergeleken met een ingesteld setpoint en aan de hand daarvan wordt het uittrekmechanisme aangestuurd.

Het uittrekmechanisme kan bijvoorbeeld een bandje zijn, een schroef, een trilgoot, of in geval van een vloeistof, een pomp.

Wanneer het product in de voorraadtrechter een minimum niveau bereikt, wordt deze automatisch bijgevuld. Tijdens het bijvullen kan de dosering op zijn laatste waarde worden vastgehouden.





Loss-in-weight & volumetrische doseerapparatuur in de praktijk

Naast ons huismerk BHT bieden we service en wisselstukken aan in de Benelux voor bekende merken zoals K-Tron en Brabender, door gespecialiseerde en ervaren technici.

Bovendien bouwen we sleutel-op-de-deuroplossingen op maat inclusief pneumatisch transport, stuurkast, refill-systemen, enzovoort.



Al onze BHT-doseerders hebben het "Easy Clean" concept. Eenvoudig te reinigen.



ONZE OPLOSSINGEN

Productinspectie

- A** Controlewegers
- B** Metaaldetectie
- C** Röntgeninspectie
- D** Testers voor metaaldetectie/
Röntgeninspectie



Dynamisch wegen

- A** Bandweging
- B** Volumemeting - bandweging
- C** Meting van de impact van het debiet
- D** Schroefweging

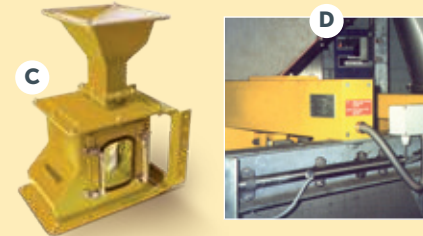
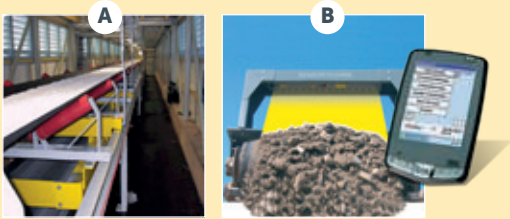

Statisch wegen

- A** Load cellen
- B** Weegplateaus

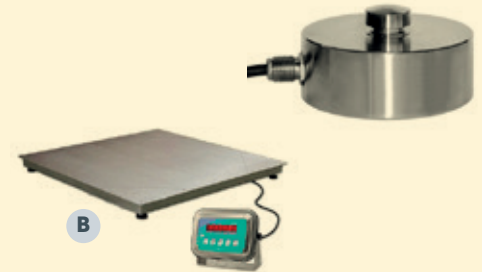

Aan-boordweging



Doseren

- A** Volumetrisch
- B** Gravimetrisch

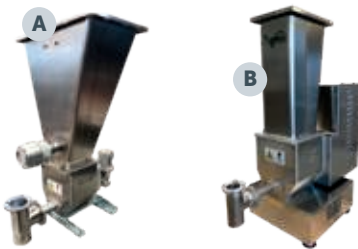

Vaste stoffen niveau schakelaars, flow detectie en flow meting

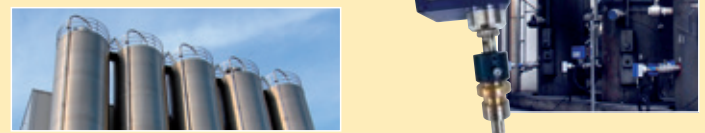

Vochtmeet systemen

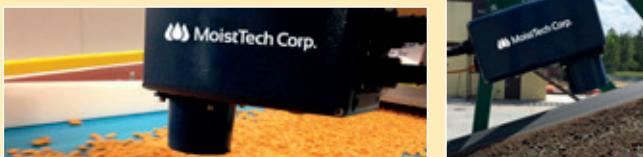

Transportband beveiliging producten



Weighing & Inspection

Hoofdkantoor: Brielstraat 112 - 9990 Maldegem - België - T. +32 50 71 09 20 - info@weighingandinspection.eu
 Chaussée de Wavre 362 - 1390 Grez-Doiceau - België - T. +32 10 84 83 90
 Kantoor Nederland: Nikkelstraat 45 - 4823 AE Breda - Nederland - T. +31 850 441 822